

# LAIR-122



## U-bracket for AIR-122

LAIR-122 is an U-bracket compatible with AIR-122 speaker. It is made from heavy-duty stainless steel and covered with scratch-resistant powder coating.

### SPECIFICATIONS

Functions	U-Bracket, Rotation, Tilt
Features	Two point rotation mounting
Dimensions (W x H x D)	480 x 320 x 90 mm / 18,9" x 12,6" x 3,5"
Weight (Net/Shipping)	2,23 kg / 4,9 lbs



### DIMENSIONS

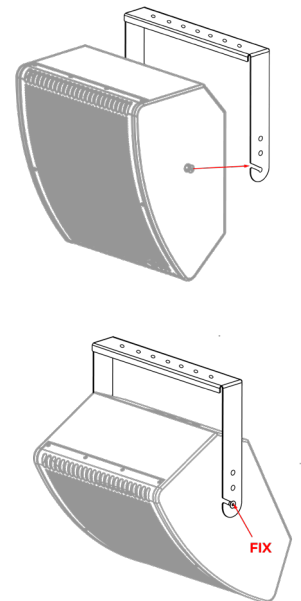
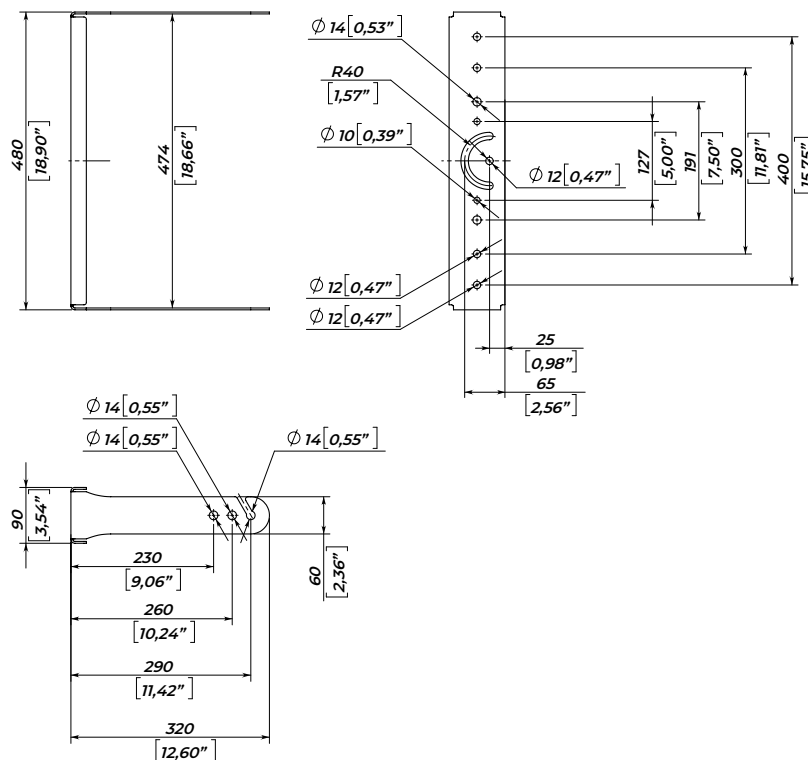

### SAFETY INSTRUCTIONS

1. Entrust mounting equipment to the experienced professionals following current safety instructions. Improperly installed equipment can result in property damage, personal injury and/or liability to the installing contractor.
2. Always use safety cables to prevent equipment from falling during setup or while exploitation.
3. Carefully check the mounting surface of the wall. Make sure wall material can hold the weight of the speaker with the mounting added.
4. Make sure to securely fix all the mounting bolts. Loose bolts may become unscrewed with time due to vibration and create safety hazard.