

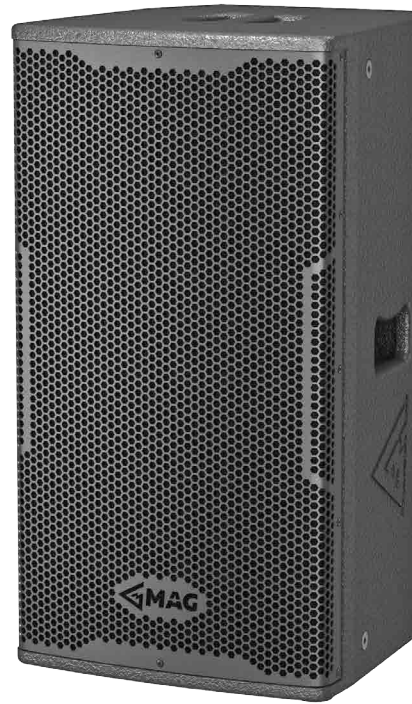

MD 402

FULL-RANGE PASSIVE SPEAKER

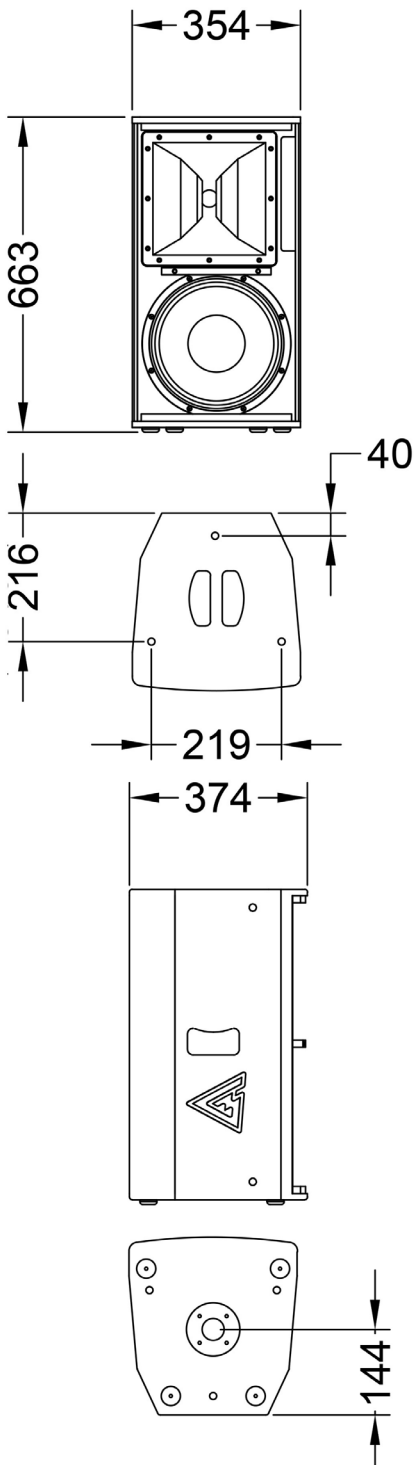

Main features:

- 500W nominal power
- 12" woofer with 3" voice coil
- 1,5" HF driver with 2,8" voice coil
- 130,5 dB Max SPL
- Bi-amp/passive crossover mode (optional)
- Pole mount adapter

Frequency Response (-10dB)	65 - 18000 Hz
Max SPL (peak)	130,5 dB (calculated)
Sensitivity (1W/1m)	97,5 dB
LF Transducer	12", M1240
HF Transducer	1,5", M150
Nominal coverage HxV	60° x 40°
Impedance	8 Ohm / 4 Ohm
Nominal power	500 W
Program power	1000 W
Peak power	2000 W

Connectors	2x Neutrik Speakon
Dimensions (WxHxD)	354x663x374 mm
Net weight	27 kg
Shipping weight	29 kg
Mounting	Pole mount adapter 12x M10 flying points
Enclosure materials	Plywood; wear-resistant paint
Grill	Steel grill, polymere protective net
Color	Black

Acoustical & Electrical data

Connections, physical data
and exploitation