

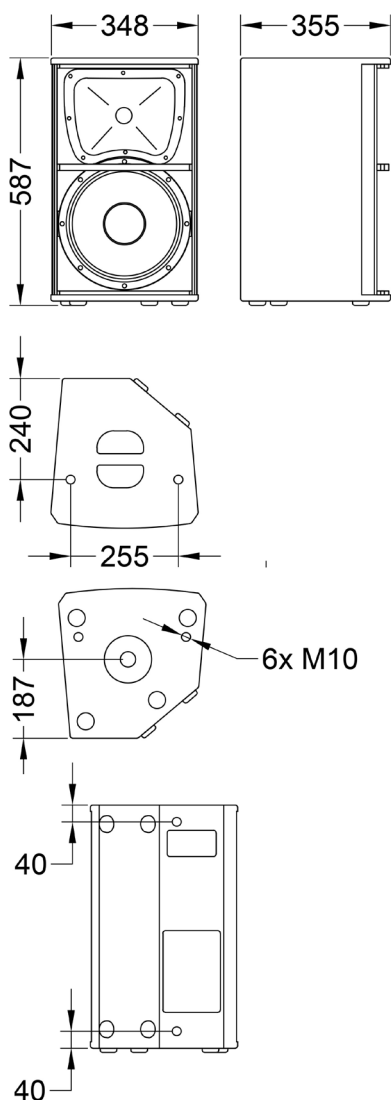

Z 220

FULL-RANGE PASSIVE SPEAKER



Main features:

- 400W nominal power
- 12" woofer with 2,5" voice coil
- 1" HF driver with 1,75" voice coil
- 128 dB Max SPL
- Pole mount adapter

Frequency Response (-10dB)	55 - 18000 Hz
Max SPL (peak)	128 dB (calculated)
Sensitivity (1W/1m)	96 dB
LF Transducer	12"
HF Transducer	1"
Nominal coverage HxV	100° x 50°
Impedance	8 Ohm / 4 Ohm
Nominal power	400 W
Program power	800 W
Peak power	1600 W

Connectors	2x Neutrik Speakon
Dimensions (WxHxD)	348x587x355 mm
Net weight	17 kg
Shipping weight	20 kg
Mounting	10x M10 flying points Pole mount adapter
Enclosure materials	Plywood; wear-resistant paint
Grill	Steel grill, polymer protective net

Acoustical & Electrical data

Connections, physical data and exploitation