

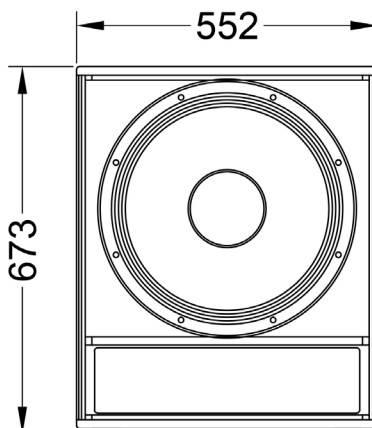

Z S18A

POWERED SUBWOOFER

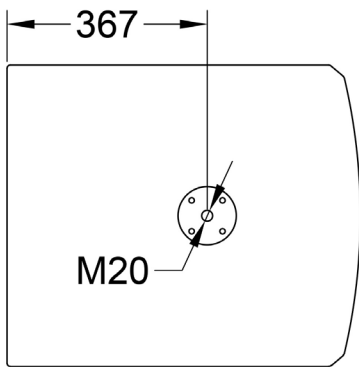
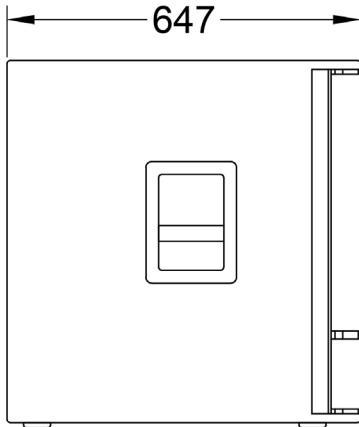

Main features:

- 500W amplifier power
- 18" woofer with 3" voice coil
- 129,5 dB Max SPL
- Effective vented box design
- M20 distance pole adapter

Frequency Response (-10dB)	40 – 300 Hz
Max SPL (peak)	129,5 dB (calculated)
LF Transducer	18"
Power	500 W
Amplifier	Class D, convection cooling
Input sensitivity	0 dBV
Connectors	2x XLR
Dimensions (WxHxD)	552x673x647 mm
Net weight	44,5 kg
Shipping weight	47,5 kg
Enclosure materials	Plywood; MDF; wear-resistant paint
Grill	Steel grill, polymer protective net

Acoustical & Electrical data

Connections, physical data and exploitation